

## **EARTHQUAKE RESPONSE ESTIMATION OF WOODEN HOUSE WITH NEW BRACE FASTENER**

**Tomoki Furuta<sup>1</sup> and Masato Nakao<sup>2</sup>**

**ABSTRACT:** A new type brace fastener which fastens the end of a diagonal wood brace to the end of column is developed for Post and Beam construction wooden houses. Since the brace fastener contains high damping rubber, it absorbs a displacement between the end of a wood brace and a column, damage of wood around wood screws is able to be prevented. On shake table test of a wood frame with a double wood brace fastened by the new brace fasteners, the new brace fastener showed higher seismic performance in comparison with normal brace fastener especially under large earthquake motion. Moreover, by means of earthquake response analysis of two-storied wooden house, it was confirmed that the new brace fastener showed good seismic performance.

**KEYWORDS:** Wooden house, Brace fastener, High damping rubber, Shake table test, Earthquake response analysis

### **1 INTRODUCTION** <sup>123</sup>

Wooden houses play an important role to preserve human life and property. They need to bear repeated large earthquakes and to be in use even after large earthquakes. However, once wood is subjected to a force, a decline of stiffness occurs. Therefore, shear stiffness of shear walls subjected to an earthquake is considered to decline, which means wooden houses are hard to resist the repeated large earthquakes.

From the expressed reason, authors have been developed a new brace fastener which fastens the end of a diagonal wood brace to the end of column for Post and Beam construction wooden houses [1, 2]. Since the brace fastener contains high damping rubber, it absorbs a displacement between the end of a wood brace and a column, damage of wood around wood screws is able to be prevented. Therefore, the brace fastener minimizes the decline of stiffness, moreover damping force by the high damping rubber is produced.

In this paper, to evaluate basic performance of the new type brace fastener, shake table test of a wood frame with a double wood brace fastened by the new brace fasteners was conducted firstly. Secondly, using the result of the

shake table test, earthquake response analysis of two-storied wooden house was conducted to evaluate the performance of the new brace fastener in ordinary Post and Beam wooden houses. The seismic performance of the new brace fastener presented in this paper is authorized officially, therefore it is able to be used under the Building Standard Law in Japan.

### **2 OUTLINE OF THE NEW BRACE FASTENER**

The new type brace fastener, as shown in Figure 1, consists of a L-shaped steel normal brace fastener, a steel plate and a high damping rubber with 5mm thick. The high damping rubber glues a L-shaped normal brace fastener and a steel plate together. The L-shaped normal brace fastener is fastened to the end of a column with nine 75mm long wood screws and the steel plate is fastened to the end of a wood brace with six 45mm long wood screws. In addition to the wood screws, four 45mm long wood screws which fasten the L-shaped fastener and a wood brace directly are added for fail-safe considering exfoliate of high damping rubber. Picture 1 shows a wood frame with a double wood brace which is fastened by the new brace fasteners at the ends of braces as shown in Picture 2.

### **3 SHAKE TABLE TEST**

Shake table test of a wood frame specimen with a double wood brace fastened by the new brace fasteners was performed to evaluate its seismic performance. Figure 2 shows a wood frame for shake table test. A double wood brace, whose cross section is 90mm x 45mm, was

<sup>1</sup> Tomoki Furuta, Daiichi Institute of Technology, 1-10-2 Kokubu-cyuou Kirishima city Kagoshima, 899-4395, Japan  
Email: t-furuta@daiichi-koudai.ac.jp

<sup>2</sup> Masato Nakao, Faculty of Engineering, Yokohama National University, 79-5 Tokiwadai Hodogaya-ku Yokohama city, 240-8501, Japan  
Email: mnakao@ynu.ac.jp

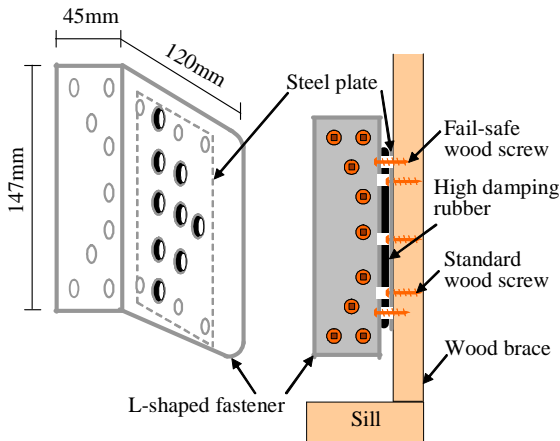

**Figure 1:** New developed brace fastener



**Picture 1:** Wood brace fastened by the new fastener



**Picture 2:** New brace fastener installed at the end of a brace

fastened by the new brace fasteners at the both ends. Wood species of column, sill and brace of the specimen was *Tsuga heterophylla* and beam was *Dugrus fur*. Since two weights on the top of the specimen were approximately 20kN in total, whole weight of the upper half of the specimen was 24.5kN.

10%, 30% and 50% of JMA Kobe wave(earthquake motion observed at Kobe branch of Japan Meteorological Agency in January 17th in 1995) were input to the specimen in one direction. Before starting the test, to have

the natural period and the damping ratio, small random wave and impulse wave were input to the specimen. Table 1 shows natural periods and damping ratios calculated from the result of 3mm impulse wave. While there is no difference in natural period between the case with the new brace fasteners and the one with normal brace fasteners, damping ratio in the case with the new brace fasteners was higher than the one with normal fasteners.

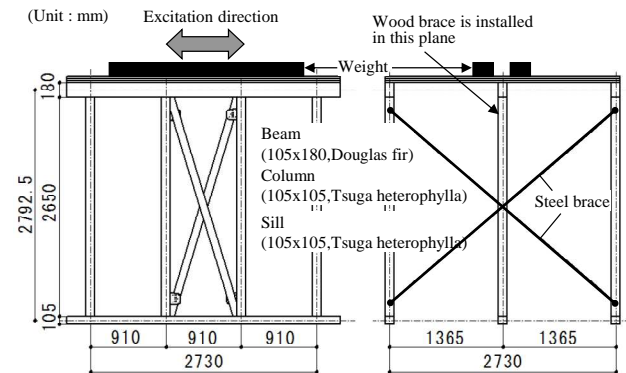

**Figure 2:** Wood frame for shake table test

**Table 1:** Natural period and damping ratio

	Natural period (sec)	Damping ratio (%)
Double wood brace with the new brace fasteners	0.341	9.5
Double wood brace with normal brace fasteners	0.343	6.2

Figure 3 and Figure 4 show relationships between shear force and story drift of the specimen with a double wood brace fastened by the new brace fasteners and normal brace fasteners respectively.

The tendency of the result of the case with the new brace fastener and the one with normal brace fastener is almost the same under 10% and 30% of JMA Kobe wave. However, in the case of 50% of JMA Kobe wave, while maximum story drift of the specimen with the new brace fasteners was 3.0%, the one with normal brace fasteners was 5.6%, so it is 1.9 times as much as the drift with the new brace fasteners.

Slight deformation of the new brace fastener was observed after the 50% of JMA Kobe excitation, however, in the case of normal brace fastener, sprit of the fastener, pull out of wood screws and buckling of a wood brace occurred.

Figure 5 shows maximum drift of the case with the new brace fastener and the one with normal fastener. In the cases under 10% and 30% of JMA Kobe wave, the maximum drifts of the two cases were almost the same. Therefore, the use of the new brace fastener is effective especially under relatively large earthquake motion.

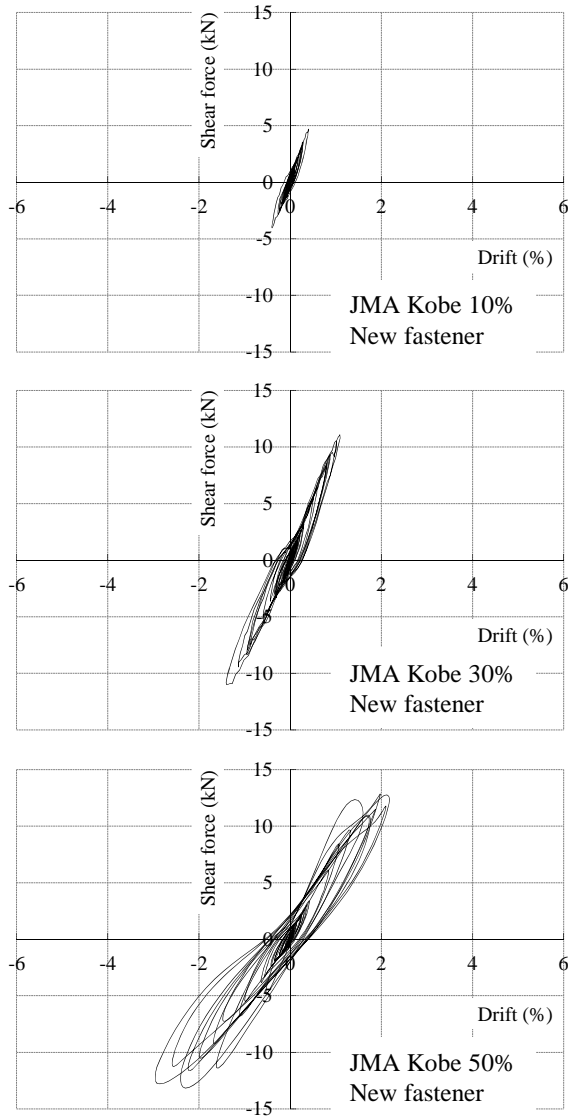

**Figure 3:** Shear force-drift relationship with double wood brace fastened by the new brace fasteners

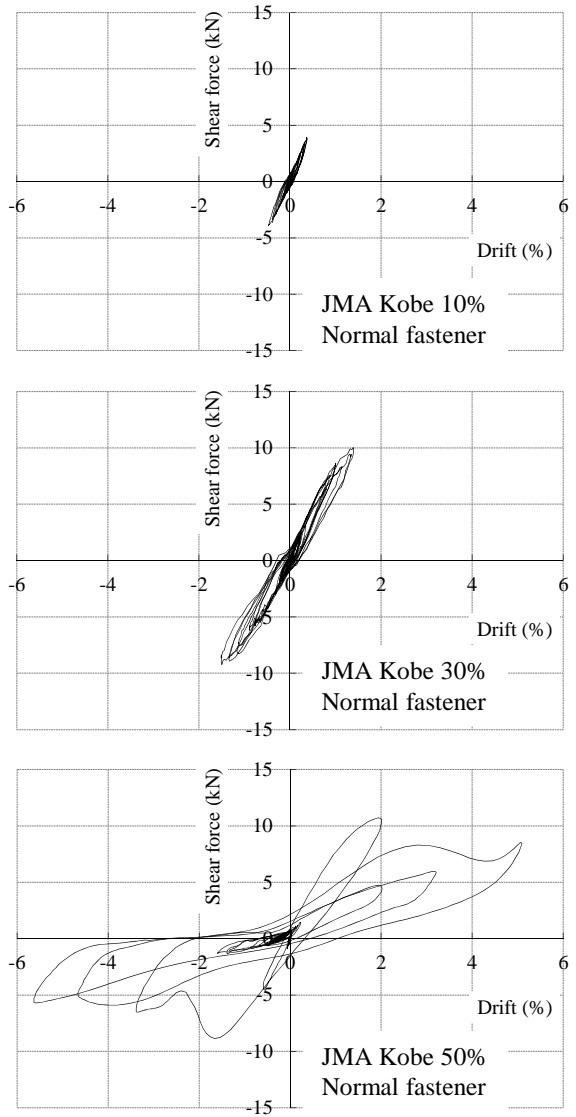

**Figure 4:** Shear force-drift relationship with double wood brace fastened by normal brace fasteners

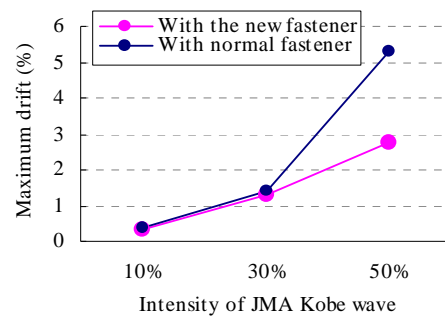

**Figure 5:** Maximum drifts of the specimen with double brace under 10%, 30% and 50% of JMA Kobe wave

## 4 EARTHQUAKE RESPONSE ANALYSIS

Earthquake response analysis of two-storied wooden houses was carried out to examine the seismic performance of the new brace fastener under earthquake motions.

Figure 6 shows analysis model of a two-storied wooden house. The non-linear diagonal springs in the model represent double wood brace and nailed plywood. Figure 7(a) shows the hysteresis model of double wood brace with the new brace fasteners which was calibrated by the shake table test results. A wood frame with double wood brace fastened by normal brace fasteners was also modelled as shown in Figure 7(b). Figure 7(c) shows the one of nailed plywood. NCL model [3] was adopted for the non-linear diagonal spring.

Figure 8 and Figure 9 shows time histories of story drift and shear force of the cases with the new brace fastener and with normal brace fastener respectively. Comparing the result of shake table test to the one of earthquake response analysis under 50% of JMA Kobe wave, there is good agreement between them. For the case of normal brace fastener, because there was serious damage to fasteners and wood braces, a minor disagreement exists. Analysis result under 30% of JMA Kobe as shown in Figure 10 shows good agreement with the shake table test result. Consequently, it is considered that the analysis models of a wood frame with the new brace fastener and normal brace fastener presented here are adequate for the use of evaluating earthquake response of wooden houses.

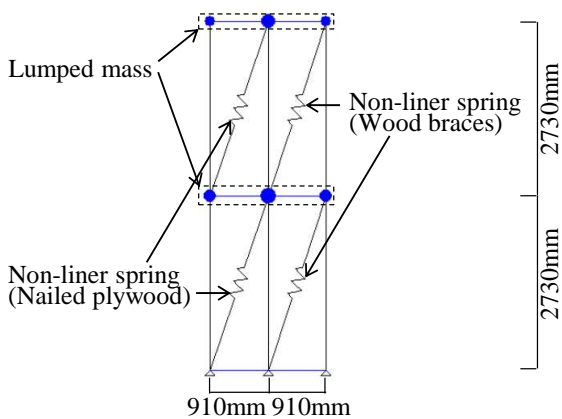
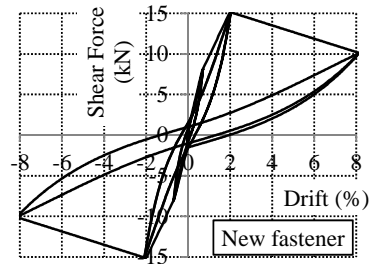
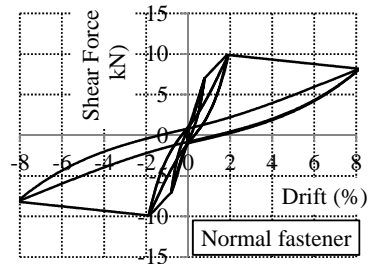

Figure 6: Analysis model of two-storied wooden house



(a) Double wood brace with the new brace fasteners



(b) Double wood brace with normal brace fasteners

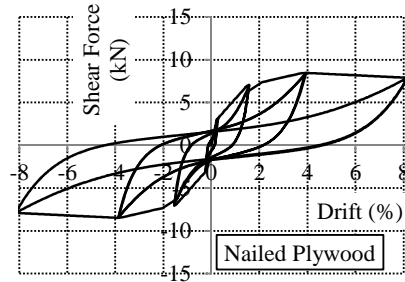

(c) Nailed plywood

Figure 7: Hysteresis model of shear walls

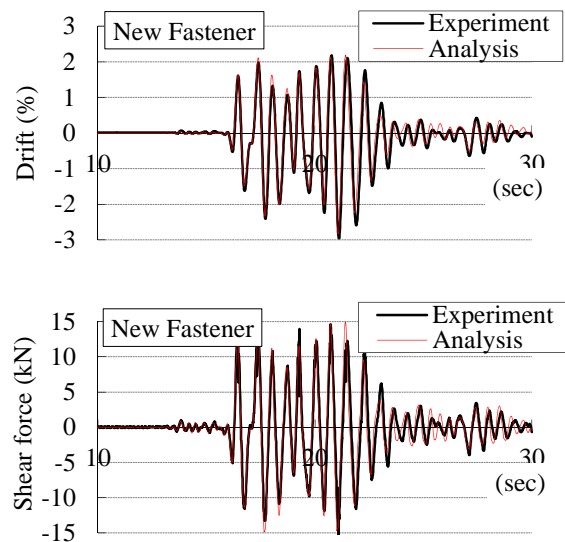
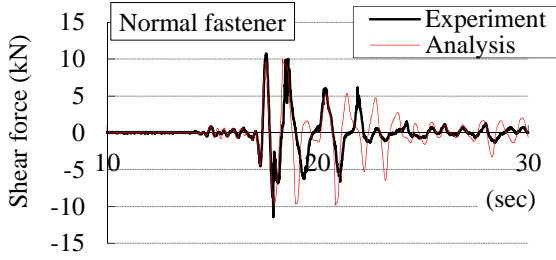
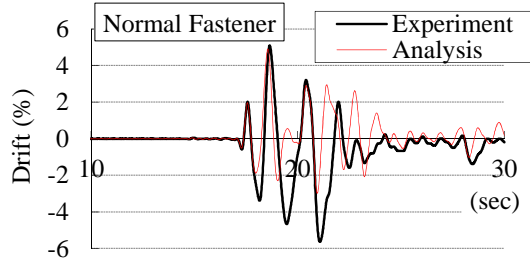
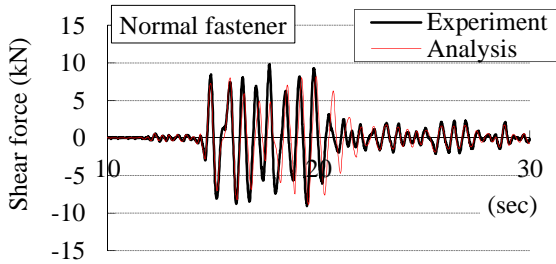
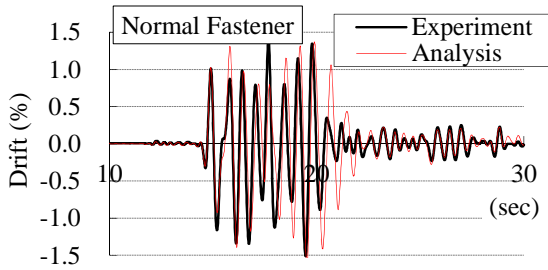

Figure 8: Time history of the case with the new brace fasteners under 50% of JMA Kobe wave



**Figure 9:** Time history of the case with normal brace fasteners under 50% of JMA Kobe wave



**Figure 10:** Time history of the case with normal brace fasteners under 30% of JMA Kobe wave

For the analysis model, five ratios of existing wall length to required wall length ( $R_e$ ) in the Building Standard Law in Japan were set as shown in Table 2. Moreover, four ratios of second floor area to first floor area ( $R_f$ ) were also considered to the analysis model. As for extra cases, The analysis model with both a double wood brace and a nailed plywood as well as the one which has twice wall length on second floor were also build and analysed. A double wood brace was arranged on the first floor and lumped masses at every node and wall length on the second floor were adjusted to meet the corresponding  $R_e$  and  $R_f$ .

Weight of the first floor ( $W_1$ ) and the one of the second floor ( $W_2$ ) of analysis models were calculated by Equation (1), (2) and (3).

$$W = 0.667 \cdot Q_a / C_0 / R_e \quad (1)$$

$$W_1 = W / (1 + R_m \cdot R_f) \quad (2)$$

$$W_2 = W - W_1 \quad (3)$$

where  $W$  is weight of whole analysis model of a two-storied wooden house ( $= W_1 + W_2$ ). It is assumed that 33% of shear force which affects a wooden house is carried by non-structural members, so 0.667 is multiplied in Equation (1).  $Q_a$  is an allowable shear strength of a double wood brace on the first floor ( $= 7.13 \text{ kN}$ ),  $C_0$  is ratio of required shear force to the weight of a building at damage limit ( $= 0.2$ ),  $R_e$  is ratio of existing wall length to required wall length,  $R_m$  is ratio of weight of unit area on the second floor to the one on the first floor (defined as 0.7 in this study),  $R_f$  is ratio of the second floor area to the first floor area. In Building Standard Law in Japan,  $Q_a$  of shear walls and  $C_0$  for wooden houses are defined as above. Natural period of the analysis model of  $R_f = 1.0$  in the case of  $R_e = 1.0$  and is 0.37 sec, the one of  $R_e = 2.0$  is 0.26 sec.

Input earthquake waves to the analysis models were JMA Kobe which was scaled down to 55% and BCJ L2 (Level 2 simulated earthquake wave for structural design by The Building Center of Japan). Figure 11 shows the response spectra of the two earthquake waves. Damping ratio of 5% was given to the all analysis models.

**Table 2:** Analysis cases

Shear wall	Ratio of existing wall length to required wall length ( $R_e$ )	Ratio of the second floor area to the first floor area ( $R_f$ )
Double wood brace	1.00	1.25
with the new brace fasteners	1.25	1.00
Double wood brace	1.50	0.75
with normal brace fasteners	1.75	0.50
Nailed plywood	2.00	

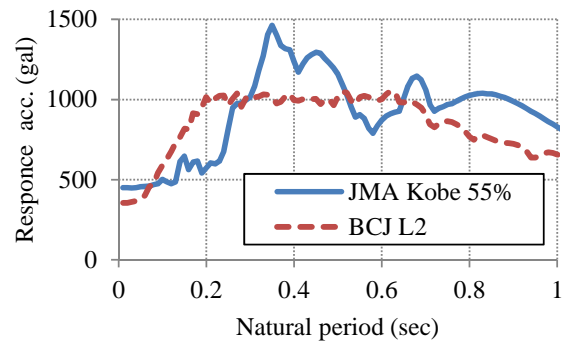

**Figure 11:** Response spectra ( $h=5\%$ )

Figure 12 shows maximum response story drift in the case of JMA Kobe wave. The response tends to decrease as  $R_e$  increases. It is also found that maximum response drifts of the cases with the new brace fastener are conservative in comparison with the ones fastened by normal brace fastener at any  $R_e$ s and  $R_f$ s. At  $R_e=1.0$ , while drifts of the cases with normal fastener are almost over 3%, the ones with the new brace fastener are generally less than 2%.

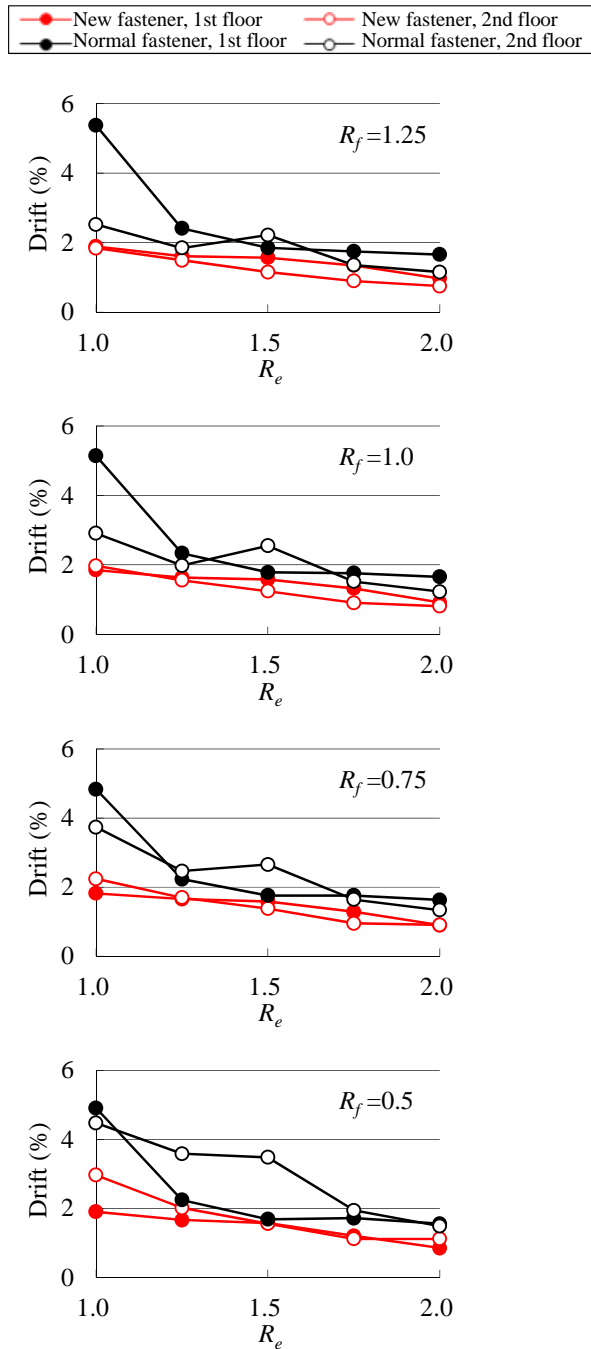

**Figure 12:** Maximum response drift of two-storied analysis model under JMA Kobe wave

Figure 13 shows the case of BCJ L2 wave. There is a same tendency as the case of JMA Kobe wave. It is found that drifts of second floor with normal fastener are generally over 3% and the ones with the new brace fastener are also less than 2% at  $R_e=1.0$ . Since drift where maximum shear force of the restoring force of the analysis model reaches is 1.8%, the use of the new brace fastener is considered to be able to keep story drift approximately below 2%.

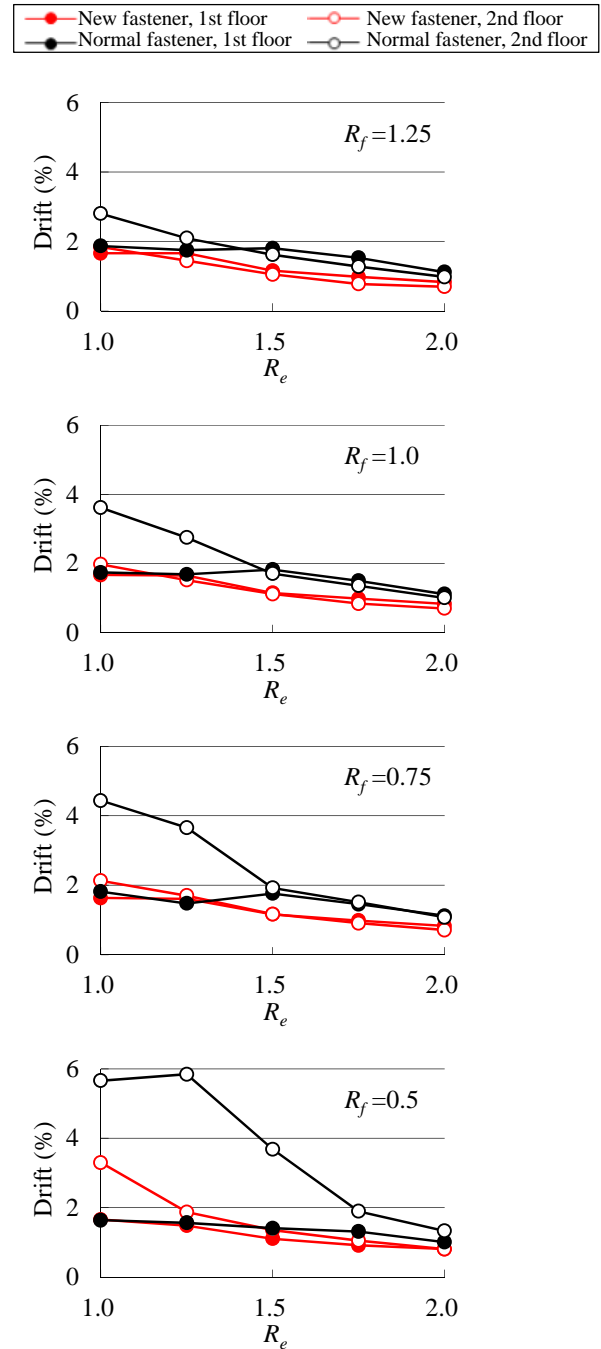

**Figure 13:** Maximum response drift of two-storied analysis model under BCJ L2 wave

Figure 14 shows the case of analysis with double wood brace together with nailed plywood. In this case, a half of allowable shear strength of the analysis model is occupied by nailed plywood whose unit allowable shear strength is 4.46 kN. In the case of analysis model with normal brace fastener, story drift decreased remarkably by replacing a half of bracing with nailed plywood especially in lower  $R_e$  cases. In the other case with the new brace fastener, there is no much difference between the case with wood brace only and the one with wood brace and nailed plywood. The reason is considered that actual seismic performance per allowable shear strength of a double wood brace with the new brace fastener is equivalent to a nailed plywood and much higher than the one with normal brace fastener as shown in Figure 15.

Figure 16 is result of analysis model which has twice  $R_e$  on second floor as much as the one on first floor. While the response drift on the second floor in this case decreased compared with the case of same  $R_e$  on first and second floor, the one on the first floor increased. The response drift on the first floor with normal brace faster is 6.1%, and the one with new brace fastener is 2.5%.

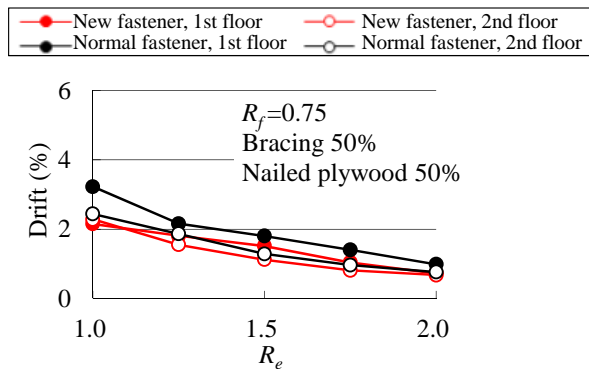

**Figure 14:** Maximum response drift of two-storied analysis model with double wood brace and nailed plywood under JMA Kobe wave

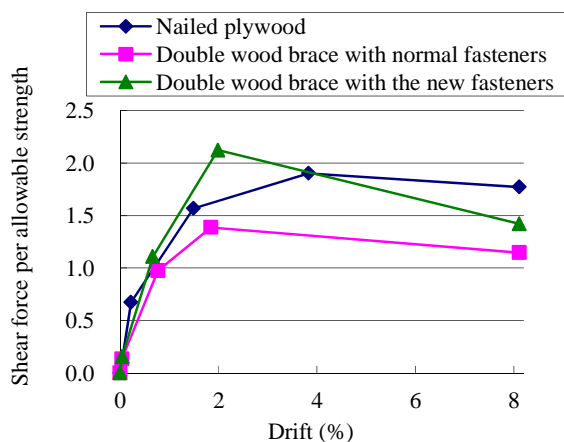

**Figure 15:** Shear force per allowable shear strength of shear walls

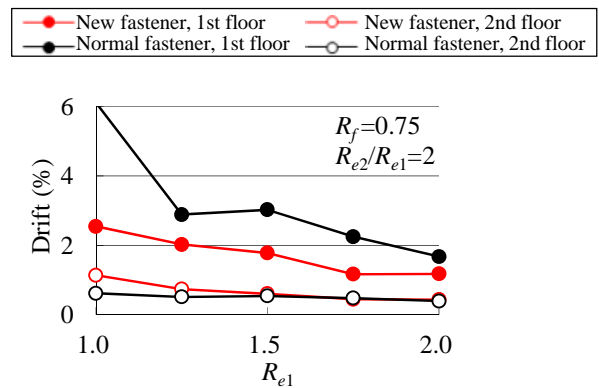

**Figure 16:** Maximum response drift of two-storied analysis model with twice  $R_e$  on second floor under JMA Kobe wave ( $R_{e1}$  :  $R_e$  on first floor,  $R_{e2}$  :  $R_e$  on second floor)

## 5 CONCLUSIONS

A new type brace fastener which fastens the end of a diagonal wood brace to the end of a column is developed for Post and Beam construction wooden houses.

On shake table test of a wood frame specimen with a double wood brace fastened by the new brace fasteners, while maximum story drift was 3%, the one with normal brace fasteners was 5.6% under 50% of JMA Kobe wave. On the tests under 10% and 30% of JMA Kobe wave, the maximum story drifts of the two cases, namely with the new fastener and with normal fastener, were almost the same. Therefore, it was found that the use of the new brace fastener is effective especially under relatively large earthquake motion.

Moreover, by means of earthquake response analysis of various two-storied wooden houses, it was confirmed that the new brace fastener showed good seismic performance. Even if story drift is estimated to be relatively large with normal brace fastener, the use of the new brace fastener is considered to be able to keep story drift approximately below 2%.

Through the above considerations, it was also found that actual seismic performance per allowable shear strength of a double wood brace with the new brace fastener is equivalent to a nailed plywood and much higher than the one with normal brace fastener.

## REFERENCES

- [1] Furuta, T. and NAKAO, M. : The Evaluation of a Damper Device with High Damping Rubber for Wooden Houses, ATC & SEI 2009 Conference on Improving the Seismic Performance of Existing Buildings and Other Structures, No.1046, 2009
- [2] Furuta, T. and Nakao, M. : The Evaluation of a Simple Damper Device with High Damping Rubber for

Wooden Houses, 14th European Conference on  
Earthquake Engineering, No.1216, 2010

- [3] Matsunaga, H., Miyazu, Y. and Soda, S. : A Universal  
Modeling Method for Wooden Shear/Nonshear Walls,  
Journal of Structural and Construction Engineering  
74: 639, 889-896, 2009 (in Japanese)